

Lecture 25: MOS transistor noise

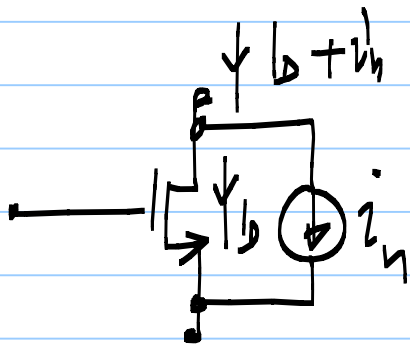

Drain current = $I_D(V_{GS}, V_{DS}) + i_n$

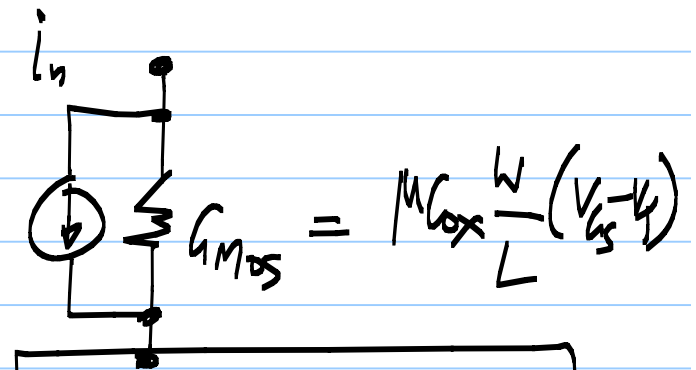
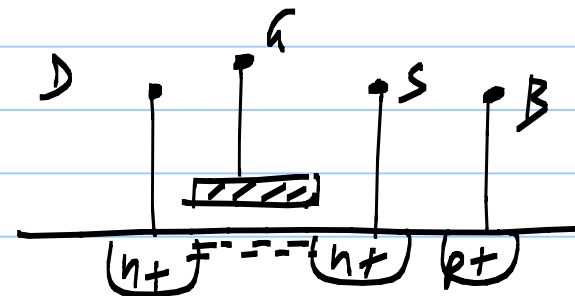
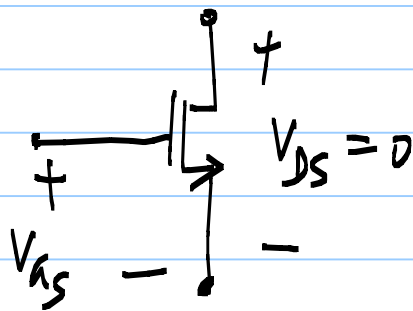

$$4kT \cdot G_{mos} = S_{i_n}$$

MOS transistor's current noise in the triode region

$$S_{i_n} = 4kT \cdot G_{MOS} \quad G_{MOS} = \mu C_{ox} \frac{W}{L} (V_{GS} - V_T)$$

In the saturation region,

$$S_{i_n} = \frac{2}{3} kT \cdot g_m \quad g_m = \mu C_{ox} \frac{W}{L} (V_{GS} - V_T)$$

OPERATING POINT

$$S_{i_n} = \frac{4kT \mu |Q_I|}{L^2} \quad \text{in all regions}$$

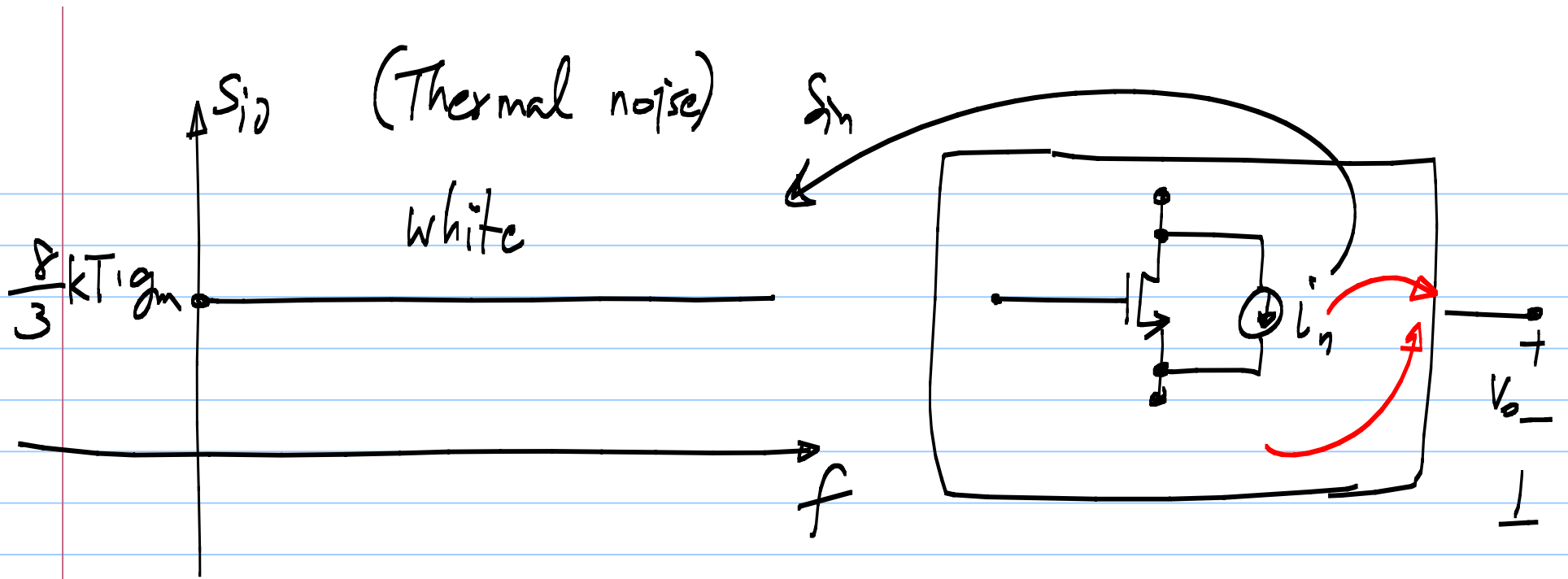

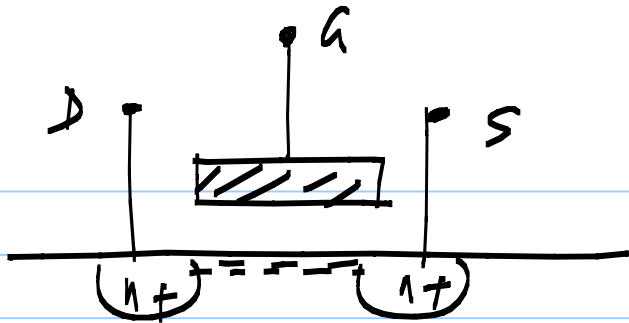

Flicker noise:

$$S_{i_n, flicker} = K \cdot \frac{I_D}{L^2} \cdot \frac{1}{f}$$

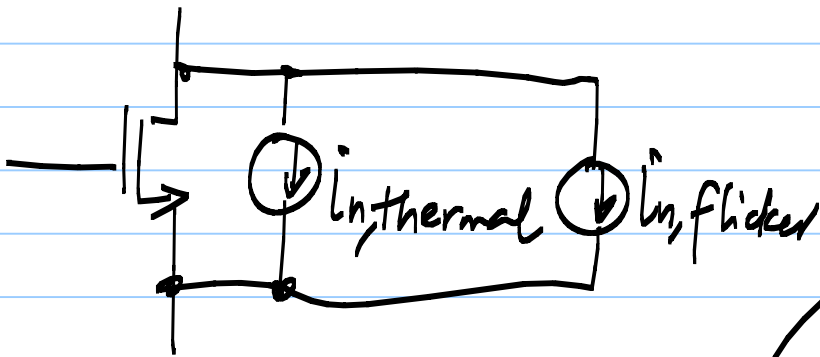

$$\frac{8}{3} kT \cdot g_m$$

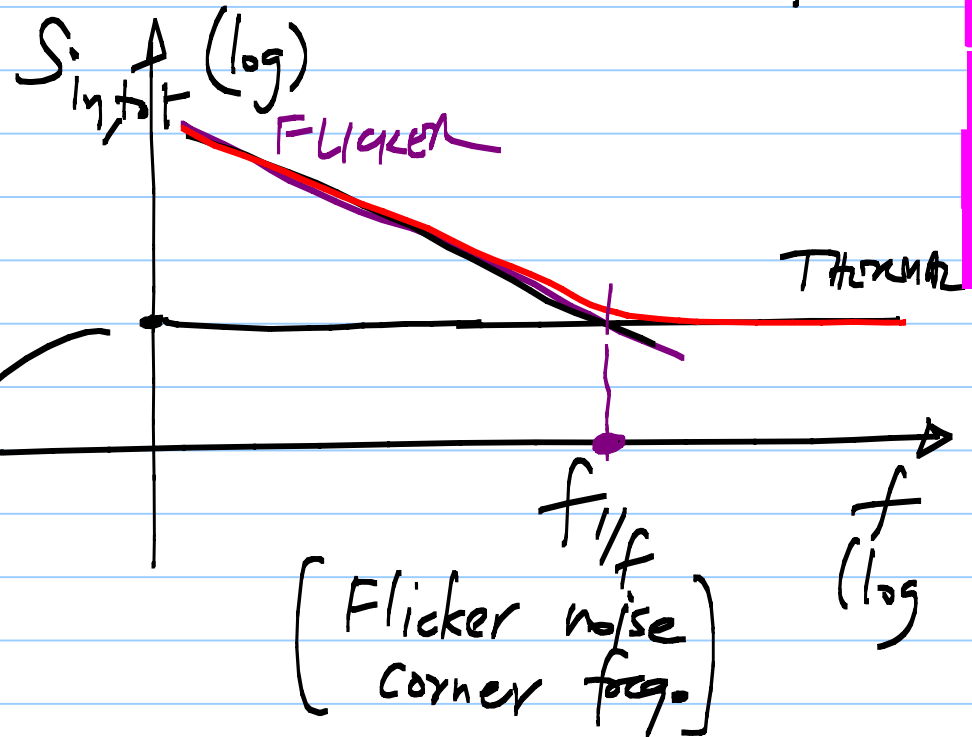

Noise in a common source amplifier :

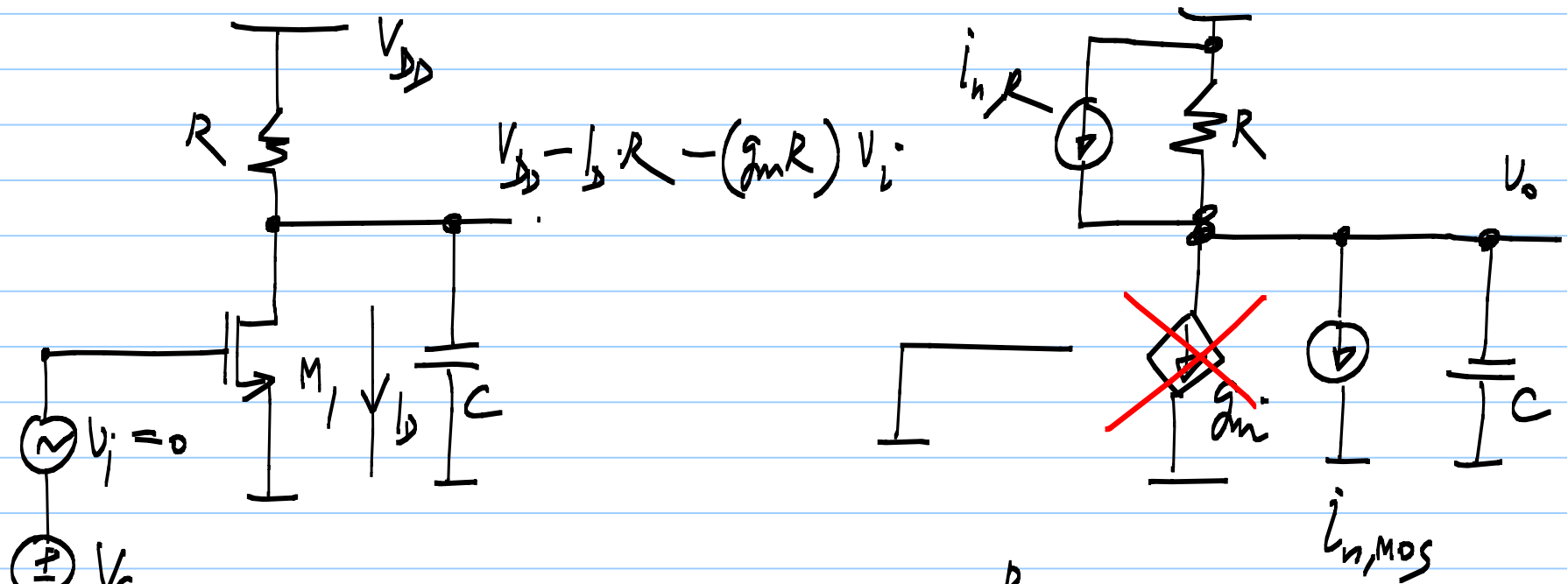

$$V_o = \frac{(I_{N,MOS} - I_{N,R}) R}{1 + sCR}$$

$$S_v(f) = (S_{i_{n,R}} + S_{i_{n,MOS}}) \frac{R^2}{1 + 4\pi^2 f^2 C^2 R^2}$$

$$S_v = (f) \left(\frac{4kT}{R} + \frac{8}{3} kT g_m + k \cdot \frac{1}{L^2} \cdot \frac{1}{f} \right) \frac{R^2}{1 + 4\pi^2 f^2 C^2 R^2}$$

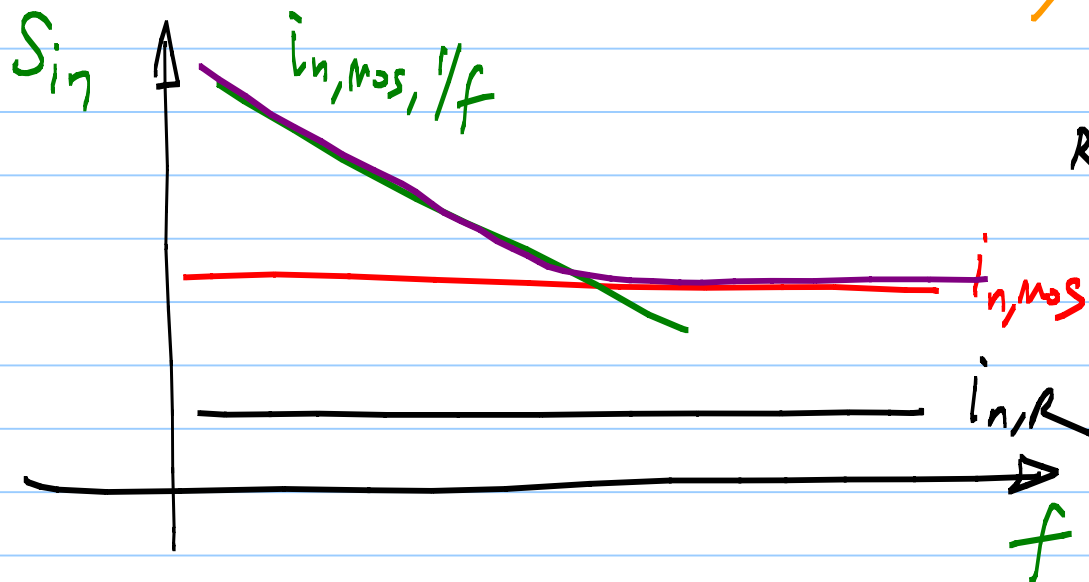

$$S_{v_o}(f) = \left(\frac{4kT}{R} + \frac{8}{3} kT \cdot g_m \right) \cdot \frac{R^2}{1 + 4\pi^2 f^2 C^2 R^2}$$

$$= \frac{8}{3} kT g_m \left(1 + \frac{3}{2} \cdot \frac{1}{g_m R} \right) \cdot \frac{R^2}{1 + 4\pi^2 f^2 C^2 R^2}$$

↑ MOS
↑ RESISTOR

$$\overline{v_n^2} = \int_0^{\infty} S_{v_o}(f) df = \frac{8}{3} kT g_m \left(1 + \frac{3}{2} \cdot \frac{1}{g_m R} \right) \cdot \frac{R^2}{4RC}$$

$$= \underbrace{\frac{2}{3} \cdot \frac{kT}{C} \cdot g_m R \left(1 + \frac{3}{2} \cdot \frac{1}{g_m R} \right)}_{\text{Noise Spectral Density}}$$

$$S_{in} = \frac{\omega}{\omega_0} kT \cdot g_m$$

$$S_{v_n} = \frac{\omega}{\omega_0} \cdot \frac{kT}{g_m}$$

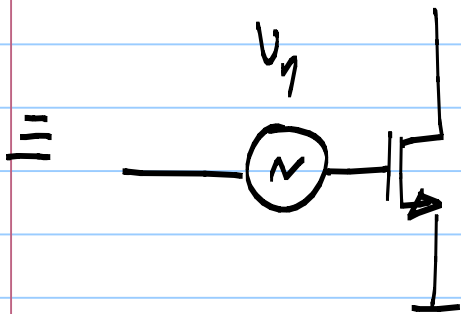
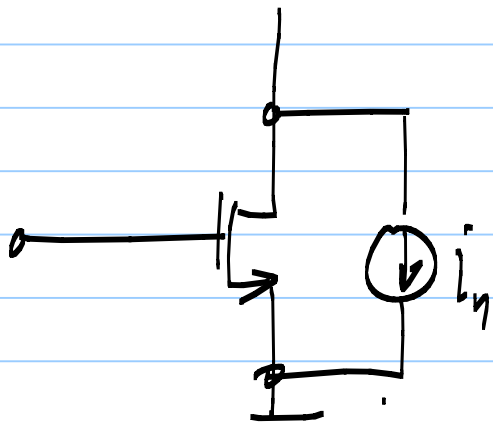

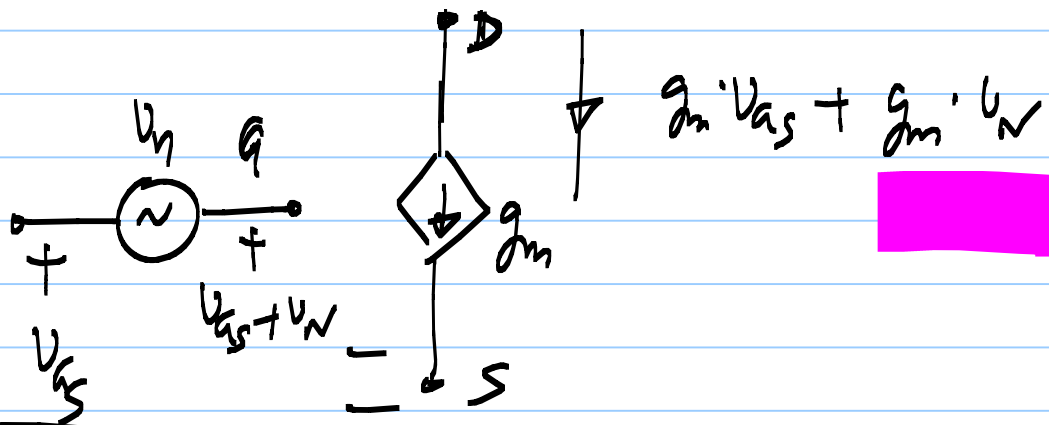
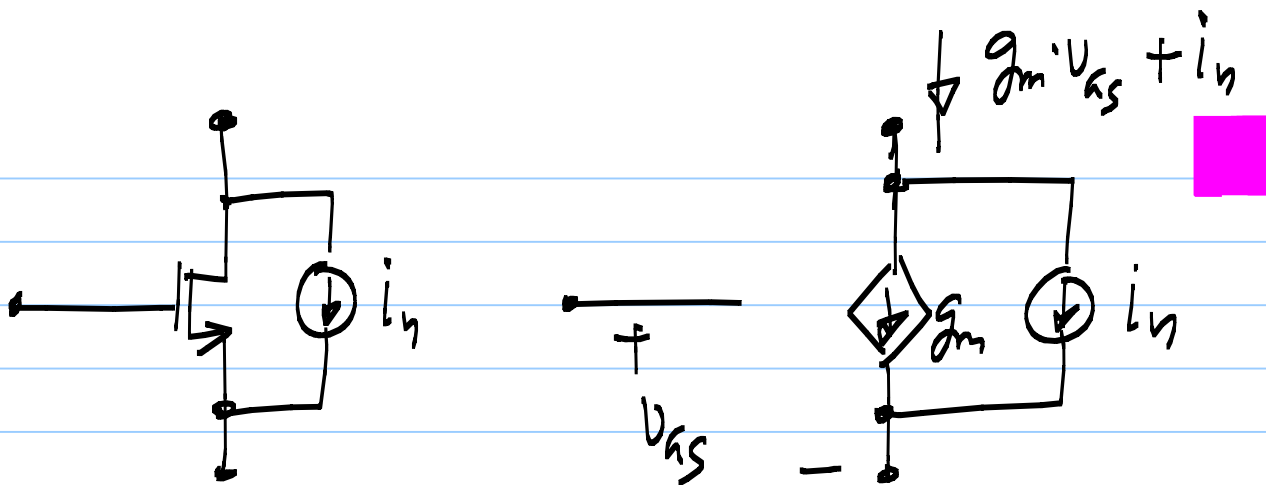

$$i_{in} = g_m v_{gs}$$

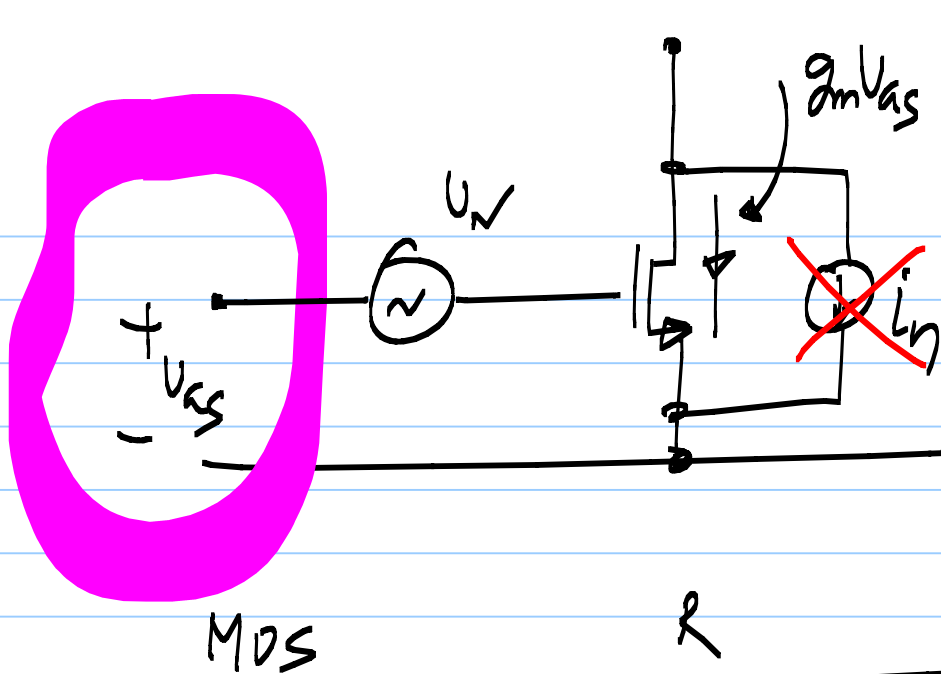

$$v_n = i_n / g_m$$

$$S_{v_n} = \frac{S_{i_n}}{g_m^2}$$

$$= \frac{8}{3} \cdot \frac{kT}{g_m}$$

$$i_n \quad \frac{8}{3} kT \cdot g_m \quad 4kT \cdot g = 4kT/R$$

$$v_n \quad \frac{8}{3} kT \frac{1}{g_m} \quad 4kT \frac{1}{g} = 4kT \cdot R$$

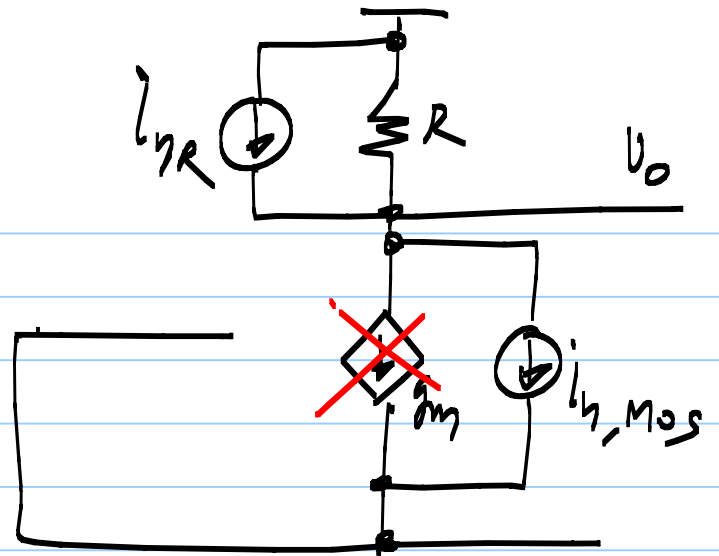
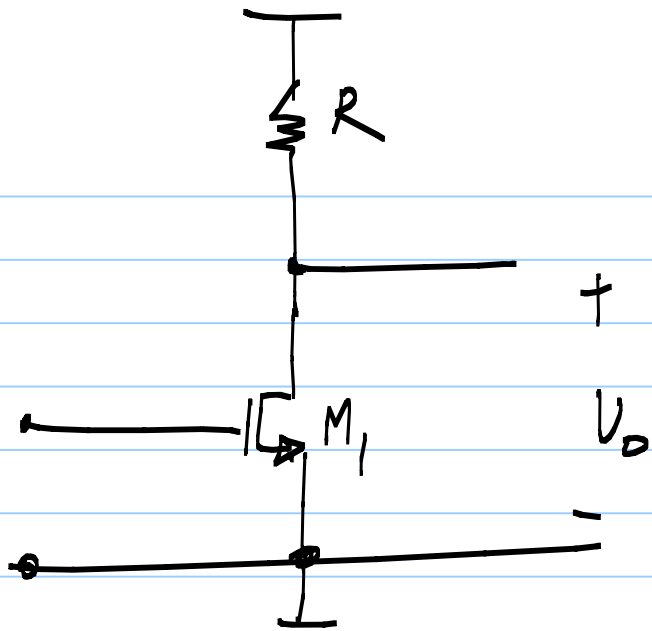

$$v_o = (i_{n,R} - i_{n,MOS}) R$$

$$S_{v_o} = (S_{i_{n,R}} + S_{i_{n,MOS}}) R^2$$

$$= \left(\frac{4kT}{R} + \frac{8}{3} kT g_m \right) R^2$$

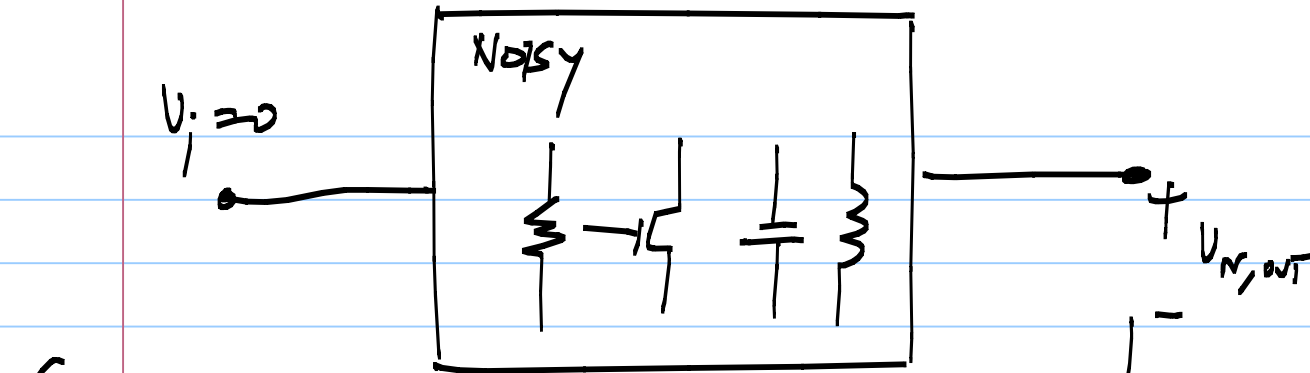

(INPUT REFLECTED)
NOISE

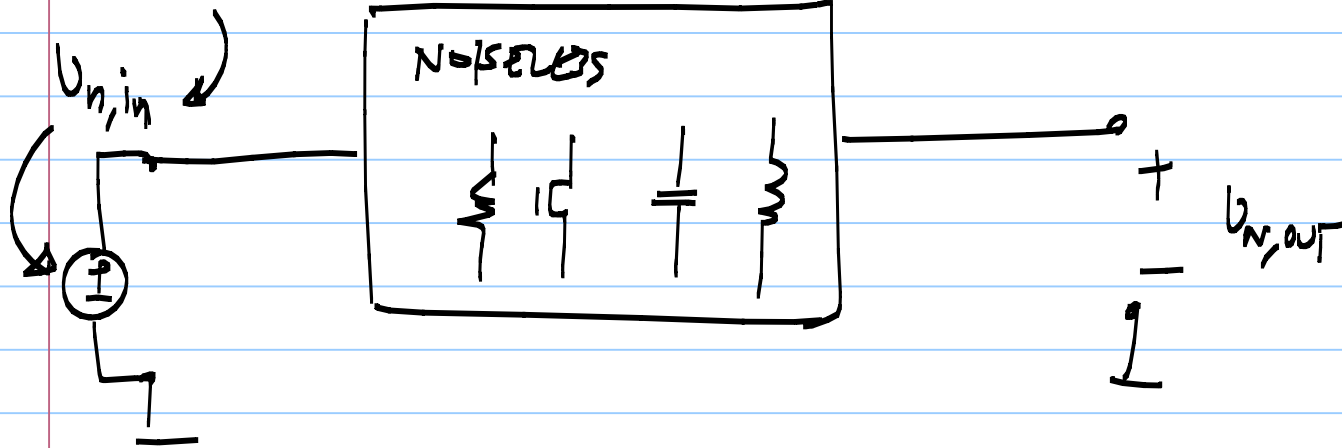

$V_{N,in}$: The input voltage that results in $V_{N,OUT}$ in a noiseless version of the circuit

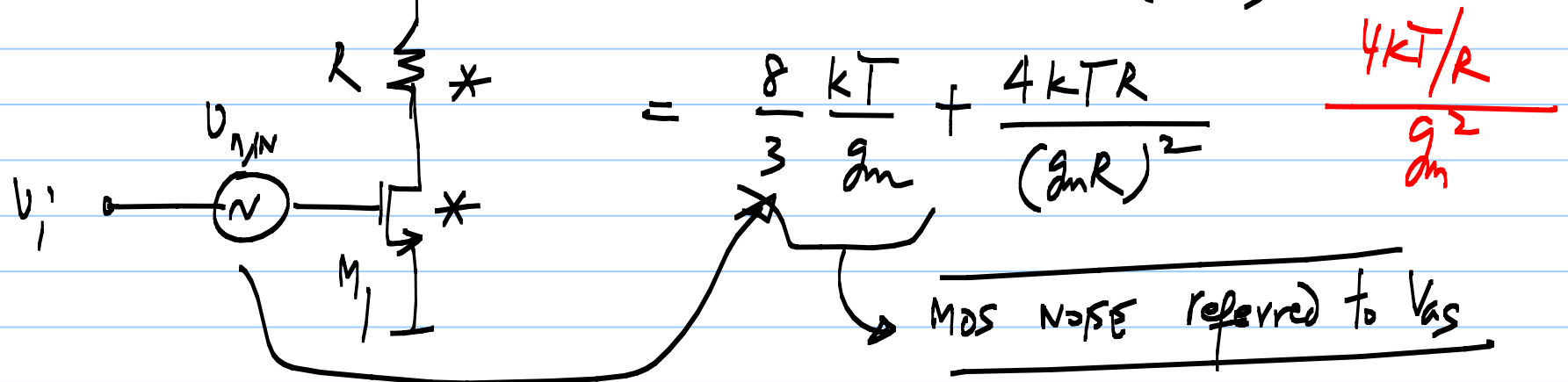
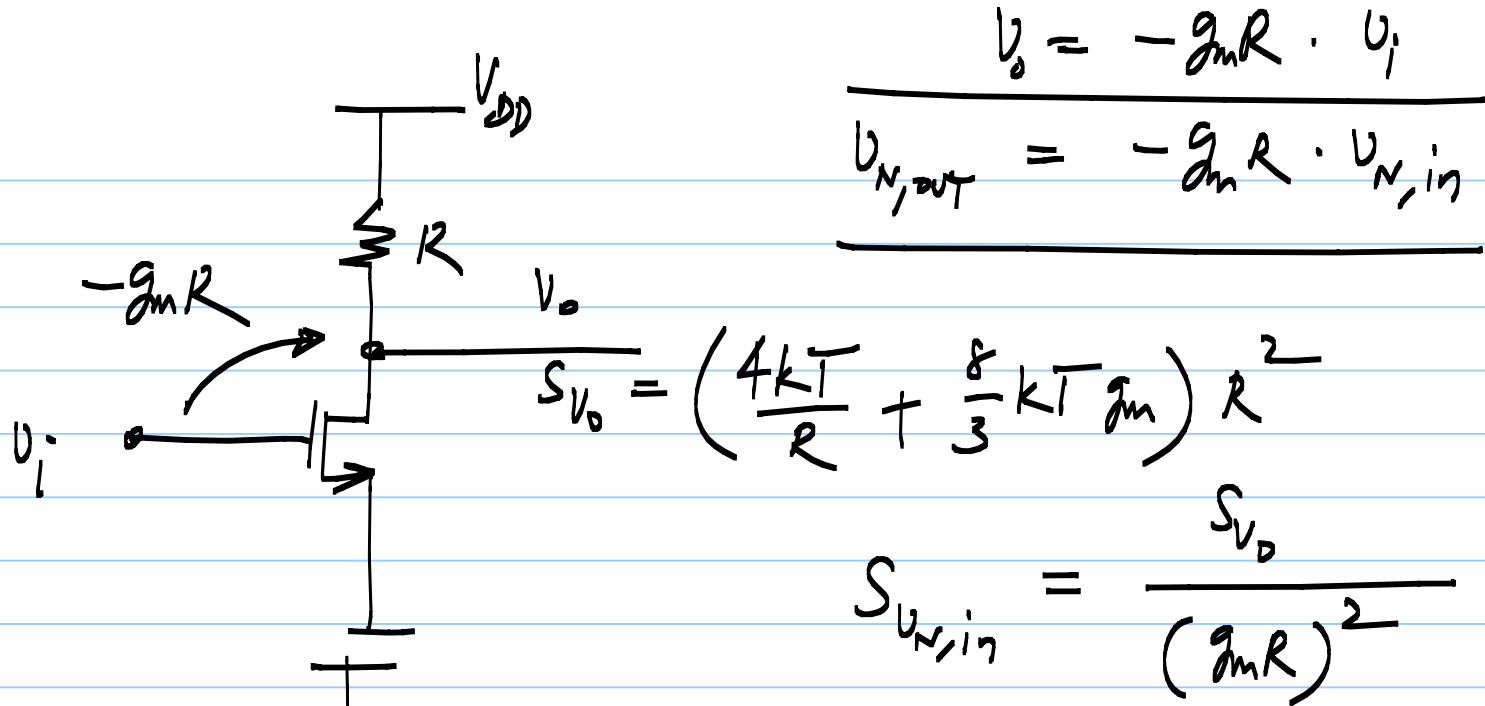

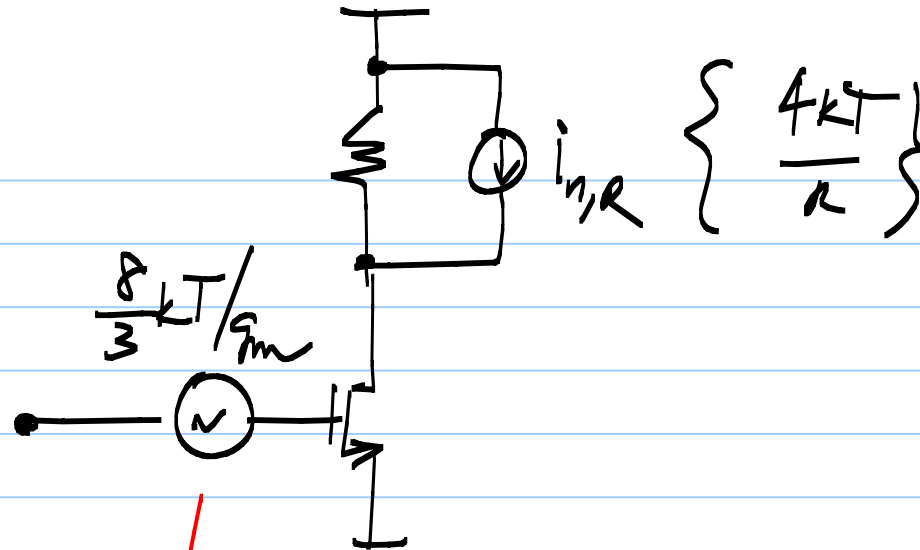

$$S_{v_{in}} = \frac{8 \cdot kT}{3 g_m} + \frac{4kT/R}{g_m^2}$$